



Thinking of you
Electrolux



EWP 1062 TDW
EWP 1462 TDW

.....
EN WASHING MACHINE

.....
USER MANUAL



CONTENTS

1. SAFETY INFORMATION	3
2. SAFETY INSTRUCTIONS	4
3. PRODUCT DESCRIPTION	5
4. CONTROL PANEL	6
5. WASHING PROGRAMMES	6
6. CONSUMPTION VALUES	8
7. OPTIONS	9
8. BEFORE FIRST USE	11
9. DAILY USE	11
10. HELPFUL HINTS AND TIPS	14
11. CARE AND CLEANING	15
12. TROUBLESHOOTING	18
13. TECHNICAL DATA	20

WE'RE THINKING OF YOU

Thank you for purchasing an Electrolux appliance. You've chosen a product that brings with it decades of professional experience and innovation. Ingenious and stylish, it has been designed with you in mind. So whenever you use it, you can be safe in the knowledge that you'll get great results every time.

Welcome to Electrolux.

Visit our website for:



Get usage advice, brochures, trouble shooter, service information:
www.electrolux.com



Register your product for better service:
www.electrolux.com/productregistration



Buy Accessories, Consumables and Original spare parts for your appliance:
www.electrolux.com/shop

CUSTOMER CARE AND SERVICE

We recommend the use of original spare parts.

When contacting Service, ensure that you have the following data available.

The information can be found on the rating plate. Model, PNC, Serial Number.



Warning / Caution-Safety information



General information and tips



Environmental information

Subject to change without notice.

1. SAFETY INFORMATION

Before the installation and use of the appliance, carefully read the supplied instructions. The manufacturer is not responsible if an incorrect installation and use causes injuries and damages. Always keep the instructions with the appliance for future reference.

1.1 Children and vulnerable people safety



WARNING!

Risk of suffocation, injury or permanent disability.

- This appliance can be used by children aged from 8 years and above and persons with reduced physical, sensory or mental capabilities or lack of experience and knowledge if they have been given supervision or instruction concerning use of the appliance in a safe way and understand the hazards involved.
- Do not let children play with the appliance.
- Keep all packaging away from children.
- Keep all detergents away from children.
- Keep children and pets away from the appliance door when it is open.
- If the appliance has a child safety device, we recommend you activate it.
- Cleaning and user maintenance shall not be made by children without supervision.

1.2 General Safety

- Before maintenance, deactivate the appliance and disconnect the mains plug from the mains socket.
- Do not change the specification of this appliance.
- Obey the maximum load volume of 6 kg (refer to the “Programme chart” chapter).

2. SAFETY INSTRUCTIONS

2.1 Installation

- Remove all the packaging and the transit bolts.
- Keep the transit bolts. When you move the appliance again you must block the drum.
- Do not install or use a damaged appliance.
- Do not install or use the appliance where the temperature is less than 0 °C or where it is exposed to the weather.
- Obey the installation instruction supplied with the appliance.
- Make sure that the floor where you install the appliance is flat, stable, heat resistant and clean.
- Do not install the appliance where the appliance door can not be fully opened.
- Always be careful when you move the appliance because it is heavy. Always wear safety gloves.
- Make sure that there is air circulation between the appliance and the floor.
- Adjust the feet to have the necessary space between the appliance and the carpet.

Electrical connection



WARNING!

Risk of fire and electrical shock.

- The appliance must be earthed.
- Make sure that the electrical information on the rating plate agrees with the power supply. If not, contact an electrician.
- Always use a correctly installed shock-proof socket.
- Do not use multi-plug adapters and extension cables.
- Make sure not to cause damage to the mains plug and to the mains cable. Should the appliance power supply cable need to be replaced, this must be carried out by our Service Centre.
- Connect the mains plug to the mains socket only at the end of the installation. Make sure that there is access to the mains plug after the installation.

- Do not pull the mains cable to disconnect the appliance. Always pull the mains plug.
- Do not touch the mains cable or the mains plug with wet hands.
- This appliance complies with the E.E.C. Directives.

Water connection

- Make sure not to cause damage to the water hoses.
- The appliance is to be connected to the water mains using the new supplied hose-sets. Old hose sets must not be reused.
- Before you connect the appliance to new pipes or pipes not used for a long time, let the water flow until it is clean.
- The first time you use the appliance, make sure that there is no leakage.

2.2 Use



WARNING!

Risk of injury, electrical shock, fire, burns or damage to the appliance.

- Use this appliance in a household environment.
- Do not change the specification of this appliance.
- Obey the safety instructions on the detergent packaging.
- Do not put flammable products or items that are wet with flammable products in, near or on the appliance.
- Do not touch the glass of the door while a programme operates. The glass can be hot.
- Make sure that you remove all metal objects from the laundry.
- Do not put a container to collect possible water leakage under the appliance. Contact the Service to ensure which accessories can be used.

2.3 Care and Cleaning



WARNING!

Risk of injury or damage to the appliance.

- Before maintenance, deactivate the appliance and disconnect the mains plug from the mains socket.
- Do not use water spray and steam to clean the appliance.
- Clean the appliance with a moist soft cloth. Only use neutral detergents. Do not use abrasive products, abrasive cleaning pads, solvents or metal objects.
- Disconnect the appliance from the mains supply.
- Cut off the mains cable and discard it.
- Remove the door catch to prevent children and pets to get closed in the appliance.

2.4 Disposal



WARNING!

Risk of injury or suffocation.

3. PRODUCT DESCRIPTION

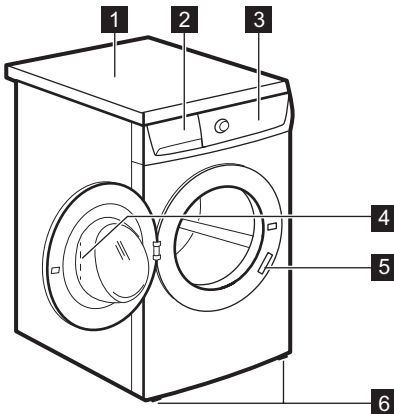

- 1** Worktop
- 2** Detergent dispenser
- 3** Control panel
- 4** Door handle
- 5** Rating plate
- 6** Feet for the appliance level

3.1 Child safety device

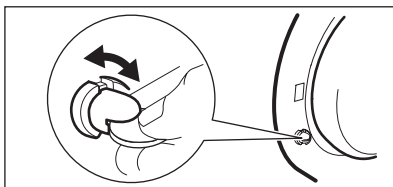

When you activate this device, you cannot close the door. This prevents children or pets to be closed in the drum. To activate the device, turn it clockwise, until the groove is horizontal. To deactivate the device, turn it counter-clockwise, until the groove is vertical.

3.2 Fixing plate kit (405517114)

Use this special accessory, when you install the appliance on a plinth. It prevents the movements of the appliance when it operates.

Read carefully the instructions supplied with this accessory.

You can buy it in all approved Service.



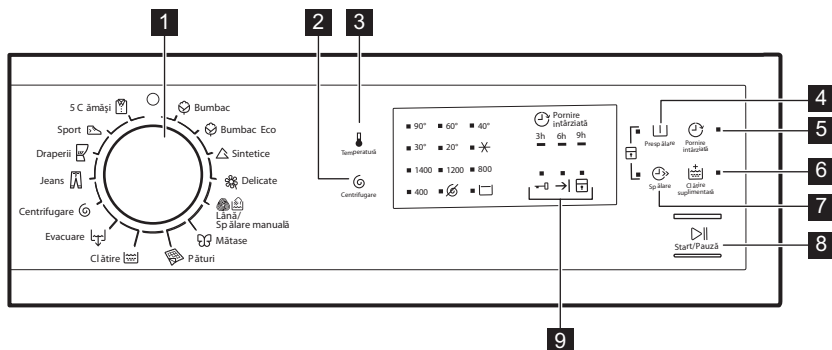







4. CONTROL PANEL



- 1** Programme knob
- 2** Spin reduction touchpad and functions indicators:
 - No spin indicator
 - Rinse hold indicator
- 3** Temperature touchpad
- 4** Prewash touchpad
- 5** Delay start touchpad
- 6** Extra rinse touchpad
- 7** Quick touchpad
- 8** Start/Pause touchpad
- 9** Programme status indicators:
 - Door locked indicator
 - End cycle indicator
 - Child lock indicator

5. WASHING PROGRAMMES

Programme Temperature range	Type of load and soil Maximum load, Maximum spin
Bumbac 90°C – Cold ()	White cotton and coloured cotton. Normal soil and light soil. 6 kg, 1000 rpm (EWP 1062TDW), 1400 rpm (EWP 1462TDW)
Bumbac Eco ¹⁾ 60 °C – 40 °C	White cotton and colour-fast cotton. Normal soil. 6 kg, 1000 rpm (EWP 1062TDW), 1400 rpm (EWP 1462TDW)
Sintetice 60 °C – Cold ()	Synthetic items or mixed fabric items. Normal soil. 3 kg, 1000 rpm (EWP 1062TDW), 1200 rpm (EWP 1462TDW)
Delicate 40 °C - Cold ()	Delicate fabrics as acrylics, viscose, polyester items. Normal soil. 3 kg, 1000 rpm (EWP 1062TDW), 1200 rpm (EWP 1462TDW)

Programme Temperature range	Type of load and soil Maximum load, Maximum spin
 Lână/Spălare manuală 40 °C – Cold (✘)	Machine washable wool, hand washable wool and delicate fabrics with «hand washing» care symbol. 2 kg, 1000 rpm (EWP 1062TDW), 1200 rpm (EWP 1462TDW)
 Mătase 30 °C	Special programme for silk and mixed synthetic items. 1 kg, 800 rpm
 Pături 60 °C – 30 °C	Special programme for one synthetic blanket, duvet, bedspread and so on. 2 kg, 800 rpm
 Clătire	To rinse and spin the laundry. All fabrics. 6 kg, 1000 rpm (EWP 1062TDW), 1400 rpm (EWP 1462TDW)
 Evacuare	To drain the water in the drum. All fabrics. 6 kg
 Centrifugare	To spin the laundry and to drain the water in the drum. All fabrics. 6 kg, 1000 rpm (EWP 1062TDW), 1400 rpm (EWP 1462TDW)
 Jeans 60 °C - Cold (✘)	Items in denim and jersey. Also for items in dark colors. 3 kg, 1000 rpm (EWP 1062TDW), 1200 rpm (EWP 1462TDW)
 Draperii 40 °C - Cold (✘)	Special programme for curtains. The prewash phase activates automatically. ²⁾ 2 kg, 800 rpm
 Sport 30 °C	Synthetic and delicate items. Light soil or items or items to refresh. 3 kg, 800 rpm
 5 Cămași 30 °C	Synthetic and mixed fabric items. Light soil and items to freshen up. For 5 - 6 shirts. 800 rpm

1) Standard programmes for the Energy Label consumption values























According to regulation 1061/2010, the “Bumbac Eco 60 °C” and “Bumbac Eco 40 °C” are respectively the “standard 60 °C cotton programme” and the “standard 40 °C cotton programme”. They are the most efficient programmes in terms of combined energy and water consumptions for washing normally soiled cotton laundry.



The water temperature of the washing phase may differ from the temperature declared for the selected programme.

2) Do not use any detergent for prewash phase.

Programme options compatibility

Programme						 1)	
	■	■	■	■	■	■	■
 Eco	■	■	■	■	■	■	■
	■	■	■	■	■	■	■
	■	■	■	■	■	■	■
 	■	■	■		■		
	■	■			■		
	■				■		
	■	■	■		■		■
					■		
	■				■		
	■	■	■	■	■	■	■
	■	■	■		■	■	■
	■	■			■		
	■	■			■		

1) When you set the Quick option, we recommend that you decrease the quantity of the laundry. It is possible to keep the full load but the washing results can be unsatisfactory. Recommended load: cotton: 3 kg, synthetics and delicates: 1,5 kg.

6. CONSUMPTION VALUES



The data of this table are approximate. Different causes can change the data: the quantity and type of laundry, the water and ambient temperature.

Pro-grammes	Load (kg)	Energy consumption (kWh)	Water consumption (litre)	Approximate programme duration (minutes)	Remaining moisture (%) ¹⁾ EWP 1062TD W	Remaining moisture (%) ¹⁾ EWP 1462TD W
Cottons 60 °C	6	1.20	70	170	60	52
Cottons 40 °C	6	0.75	72	145	60	52
Synthetics 40 °C	3	0.60	57	95	37	35
Delicates 40 °C	3	0.60	65	75	37	35
Wool/Hand wash 30 °C	2	0.30	48	55	32	30
Standard cotton programmes						
Standard 60 °C cotton	6	0.98	51	225	60	52
Standard 60 °C cotton	3	0.67	42	153	60	52
Standard 40 °C cotton	3	0.47	43	154	60	52

¹⁾ At the end of spin phase.

Off Mode (W)	Left On Mode (W)
0.75	0.75

The information given in the charts above are in compliance with the EU Commission regulation 2015/2010 implementing directive 2009/125/EC.

7. OPTIONS

7.1 Temperature

Set this option to change the default temperature.

Indicator  = cold water.

The indicator of the set temperature comes on.

7.2 Spin

With this option you can change the default spin speed.

The indicator of the set speed comes on.

Additional spin options:

No Spin

- Set this option to deactivate all spin phases. Only the drain phase is available.
- The related indicator comes on.
- Set this option for very delicate fabrics.
- The rinses phase uses more water for some washing programmes.

Rinse Hold

- Set this option to prevent the laundry creases.
- The related indicator comes on.
- There is a water in the drum when the programme is completed.
- The drum turns regularly to prevent the laundry creases.
- The door stays locked.
- You must drain the water to unlock the door.



To drain the water refer to 'At the end of the programme'.

7.3 Prewash

With this option you can add a prewash phase to a washing programme. Use this option for heavy soil.

When you set this option the programme duration increases.

The related indicator comes on.

7.4 Delay Start

With this option you can delay the start of a programme by 9, 6 or 3 hours.

The indicator of the option and the indicator of the set value are on.

7.5 Extra Rinse

With this option you can add some rinses to a washing programme.

Use this option for persons allergic to detergents and in areas where the water is soft.

The related indicator comes on.

7.6 Quick

With this option you can decrease the programme duration.

Use this option for items with light soil or items to refresh.

The related indicator comes on.



7.7 Child Lock

With this option you can prevent that the children play with the control panel.

- To **activate/deactivate** the option,



press  and  at the same time until the indicator  **comes on/goes off**.

You can activate this option:

- After you press , the options and the programme knob are locked.
- Before you press : the appliance cannot start.

7.8 Permanent extra rinse

With this option you can permanently have an extra rinse when you set a new programme.

- To **activate/deactivate** this option press  and  at the same time until the indicator  **comes on/goes off**.

7.9 Acoustic signals

The acoustic signals operate when:

- The programme is completed.
- The appliance has a malfunction.

To **deactivate/activate** the acoustic signals,

press  and  at the same time for 6 seconds.



If you deactivate the acoustic signals, they continue operate when the appliance has a malfunction.

8. BEFORE FIRST USE

1. Put 2 litre of water in the detergent compartment for washing phase. This activates the drain system.
2. Put a small quantity of detergent in the compartment for washing phase.
3. Set and start a programme for cotton at the highest temperature without laundry. This removes all possible dirt from the drum and the tub.

9. DAILY USE

- Open the water tap.
- Connect the mains plug to the mains socket.

9.1 Loading the laundry

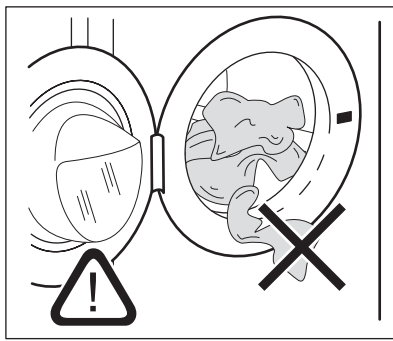

1. Open the appliance door.
2. Put the laundry in the drum, one item at a time. Shake the items before you put them in the appliance. Make sure not to put too much laundry in the drum.
3. Close the door.



CAUTION!

Make sure that no laundry stays between the seal and the door. There is a risk of water leakage or damage to the laundry.

9.2 Using detergent and additives

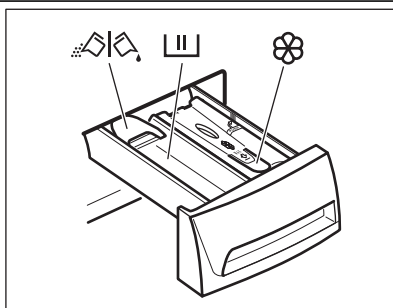

When you set a programme with a prewash, put the detergent for prewashing phase directly into the drum.

- Measure out the detergent and the fabric conditioner.
- Carefully close the detergent drawer.



Detergent compartment for washing phase.



Compartment for liquid additives (fabric conditioner, starch).



Flap for powder or liquid detergent.

Liquid or powder detergent

1.

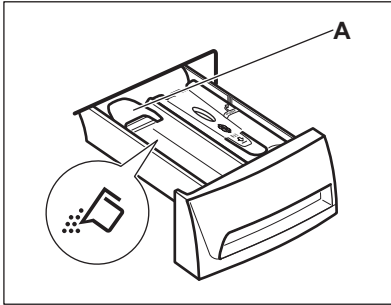

2.

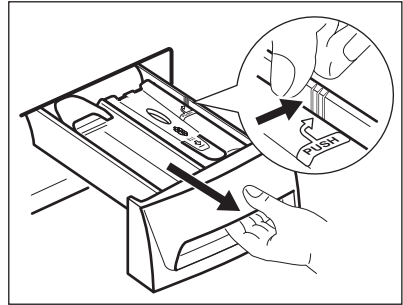

3.

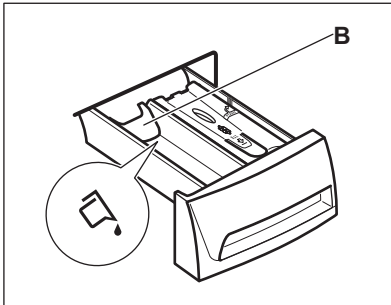

4.

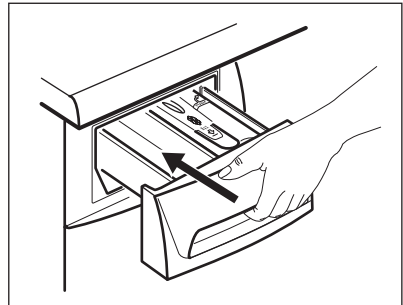

- Position **A** for powder detergent (factory setting).
- Position **B** for liquid detergent.

**When you use the liquid detergent:**

- Do not use gelatinous or thick liquid detergents.
- Do not put more liquid than the maximum level.
- Do not set the prewash phase.
- Do not set the delay start.

9.3 Setting a programme



1. Turn the programme knob and set the programme:
 - The indicator of the  flashes.
2. If necessary, change the temperature and the spin speed or add available options. When you activate an option, the indicator of the set option comes on.





If you set something incorrect, the indicator  flashes red.

9.4 Starting a programme without the delay start

Press the :

- The indicator of the  stops to flash and stays on.
- The programme starts, the door locks, the indicator  is on
- The drain pump can operate for a short time when the appliance fills water.



9.5 Starting a programme with the delay start

- Press  to set the delay you want to set. The indicator of the set delay is on. The indicator  is on.
- Press :
 - The appliance starts the countdown.
 - When the countdown is completed, the programme starts automatically.





You can cancel or change the set of the delay start before you press the .

To cancel the delay start:

1. Press  to set the appliance to pause.
2. Press  until the indicator of the set delay goes off.
Press  again to start the programme immediately.

9.6 Interrupting a programme and changing the options

You can change only some options before they operate.

1. Press . The indicator flashes.
2. Change the options.
3. Press  again. The programme continues.

9.7 Cancelling a programme

1. Turn the programme knob to  to cancel the programme and to deactivate the appliance.
2. Turn the programme knob again to activate the appliance. Now, you can set a new washing programme.



The appliance does not drain the water.

9.8 Opening the door



While a programme or the delay start operates, the appliance door is locked and the indicator  is on.



CAUTION!

If the temperature and level of the water in the drum are too high, you cannot open the door.





Open the appliance door when the delay start operates:

1. Press the  to pause the appliance.
2. Wait until the door lock indicator  goes off.
3. You can open the door.
4. Close the door and press the  again. The delay start continues to operate.



Open the appliance door when the programme operates:

1. Turn the programme knob to  to deactivate the appliance.
2. Wait for some minutes and then open the appliance door.
3. Close the appliance door.
4. Set the programme again.

9.9 At the end of the programme



- The appliance stops automatically.
- The acoustic signal operates (if it is activated).
- The indicator  goes off.
- The door lock indicator  goes off.
- The indicator  is on.
- You can open the door.
- Remove the laundry from the appliance. Make sure that the drum is empty.
- Keep the door ajar, to prevent the mildew and odours.
- Close the water tap.
- Turn the programme knob to  to deactivate the appliance.

The washing programme is completed, but there is water in the drum:

- The drum turns regularly to prevent the creases in the laundry.
- The door lock indicator  is on. The indicator  flashes. The door stays locked.
- You must drain the water to open the door.

To drain the water:

1. If necessary, decrease the spin speed. If you set , the appliance only drains.

2. Press . The appliance drains the water and spins.
3. When the programme is completed and the door lock indicator  goes off, you can open the door.
4. Turn the programme knob to  to deactivate the appliance.



The appliance drains and spins automatically after approximately 18 hours (except for Wool programme).

9.10 Stand-by

Some minutes after the end of the washing programme, if you do not deactivate

the appliance, the energy saving status activates.

The energy saving status decreases the energy consumption when the appliance is on the stand by.

- All indicators go off.
- The indicator of the  flashes slowly
- Press one of the options to deactivate the energy saving status.

10. HELPFUL HINTS AND TIPS

10.1 The laundry load

- Divide the laundry in: white, coloured, synthetics, delicates and wool.
- Obey the washing instructions that are on the laundry care labels.
- Do not wash together white and coloured items.
- Some coloured items can discolour with the first wash. We recommend that you wash them separately for the first times.
- Button up pillowcases, close zippers, hooks and poppers. Tie up belts.
- Empty the pockets and unfold the items.
- Turn inside out multilayered fabrics, wool and items with painted illustrations.
- Remove hard stains.
- Wash with a special detergent heavy soil stains.
- Be careful with the curtains. Remove the hooks or put the curtains in a washing bag or pillowcase.
- Do not wash in the appliance :
 - Laundry without hems or with cuts
 - Underwired bras.
 - Use a washing bag to wash small items.

- A very small load can cause balance problems with the spin phase. If this occurs, adjust manually the items in the tub and start the spin phase again.

10.2 Stubborn stains

For some stains, water and detergent is not sufficient.

We recommend that you remove these stains before you put the items in the appliance.

Special stain removers are available. Use the special stain remover that is applicable to the type of stain and fabric.

10.3 Detergents and additives

- Only use detergents and additives specially made for washing machines.
- Do not mix different types of detergents.
- To help the environment, do not use more than the correct quantity of detergent.
- Obey the instructions that you find on the on packaging of these products.
- Use the correct products for the type and colour of the fabric, the programme temperature and the level of soil.
- If your appliance has not the detergent dispenser with the flap device, add the liquid detergents with a dosing ball.

10.4 Ecological hints

- Set a programme without the prewash phase to wash laundry with normal soil.
- Always start a washing programme with the maximum load of laundry.
- If necessary, use a stain remover when you set a programme with a low temperature.
- To use the correct quantity of the detergent, check the water hardness of your domestic system

10.5 Water hardness

If the water hardness in your area is high or moderate, we recommend that you use

a water softener for washing machines. In areas where the water hardness is soft it is not necessary to use a water softener. To know the water hardness in your area, contact your local water authority. Use the correct quantity of the water softener. Obey the instructions that you find on the packaging of the product.

11. CARE AND CLEANING



WARNING!

Before maintenance, disconnect the appliance from the mains supply.

11.1 External cleaning

Clean the appliance only with soap and warm water. Fully dry all the surfaces.



CAUTION!

Do not use alcohol, solvents or chemical products.

11.2 Descaling

If the water hardness in your area is high or moderate, we recommend that you use a water softener for washing machines. Regularly examine the drum to prevent limescale and rust particles.

11.4 Door seal

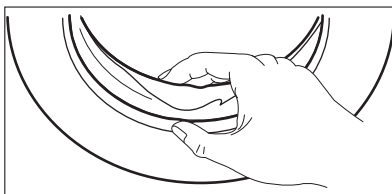

To remove rust particles use only special products for washing machine. Do this separately from the laundry wash.



Always obey the instructions that you find on the packaging of the product.

11.3 Maintenance wash

With the low temperature programmes it is possible that some detergent stays in the drum. Make regularly a maintenance wash. To do this:

- Remove the laundry from the drum.
- Set the cotton programme with the highest temperature with a small quantity of detergent.

Regularly examine the seal and remove all objects from the inner part.

11.5 Cleaning the detergent dispenser

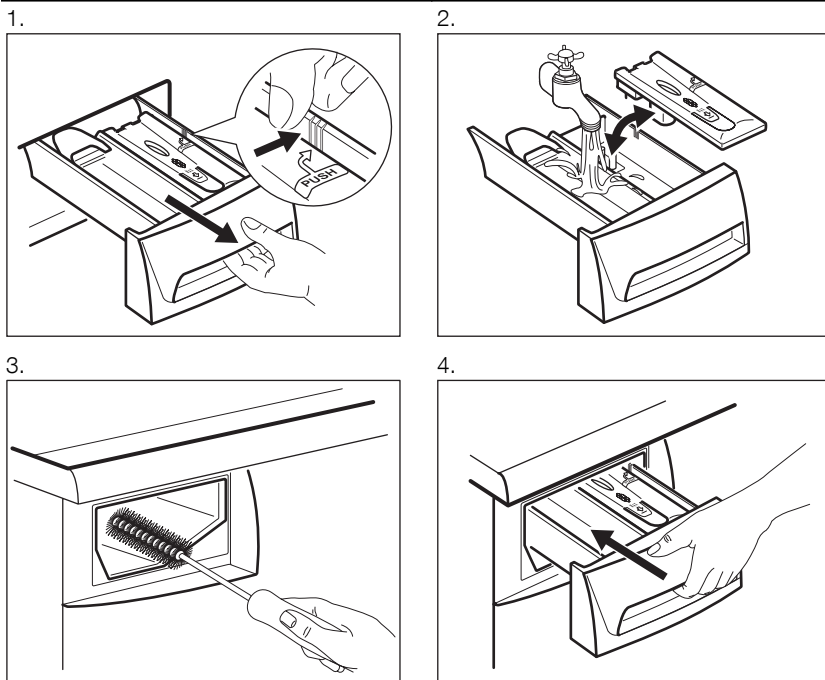

11.6 Cleaning the drain filter



WARNING!

Do not clean the drain filter if the water in the appliance is hot.

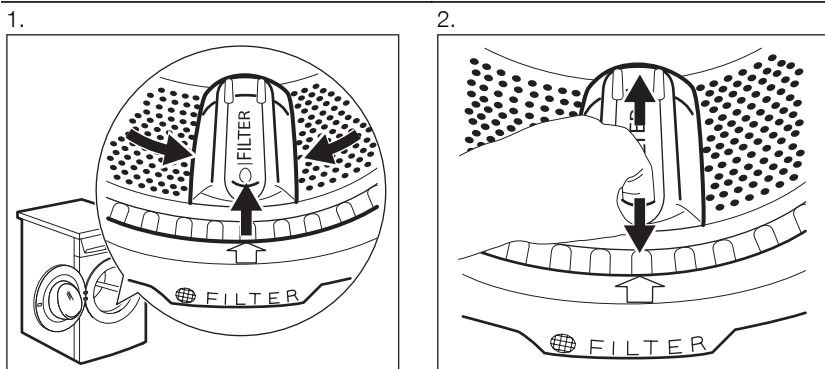

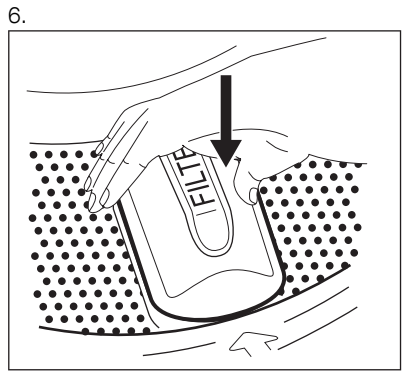
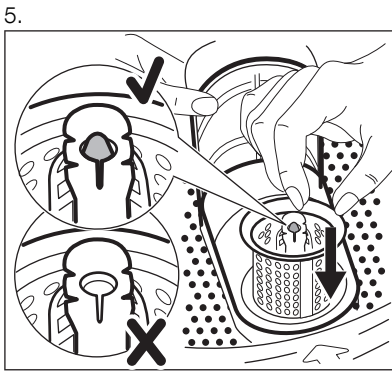
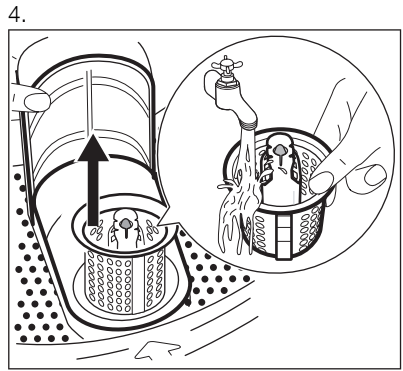
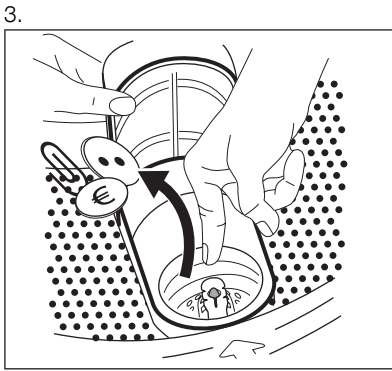

11.7 Cleaning the inlet hose and the valve filter

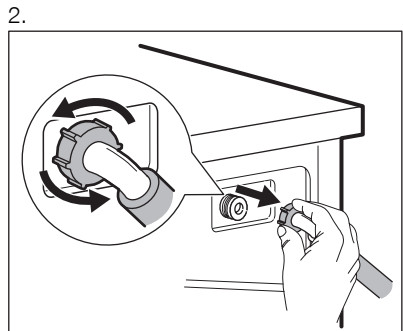
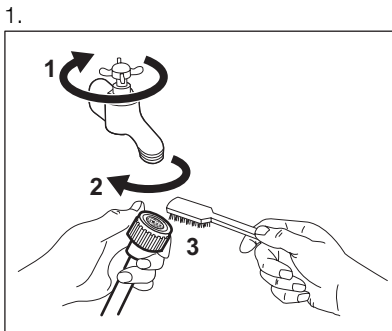

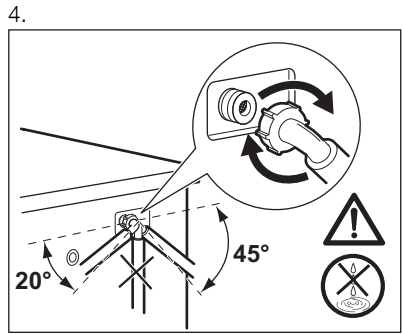
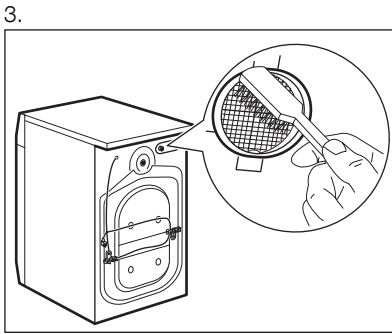

11.8 Frost precautions

If the appliance is installed in an area where the temperature can be less than 0 °C, remove the remaining water from the inlet hose and the drain pump.

i Do this procedure also when you want to do the emergency drain.

1. Disconnect the mains plug from the mains socket.
2. Close the water tap.
3. Remove the water inlet hose.
4. Remove the drain hose from the rear support and unhook it from sink or spigot.

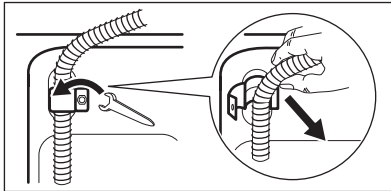

5. Put the ends of the drain and inlet hose in a container. Let the water flow out of the hoses.
6. When no more water flows, install the inlet hose and the drain hose again.



WARNING!



Make sure that the temperature is more than 0 °C before you use the appliance again. The manufacturer is not responsible for damages caused by low temperatures.

12. TROUBLESHOOTING

The start of the appliance does not occur or it stops during operation. First try to find a solution to the problem (refer to the table). If not, contact the Service.

With some problems, the acoustic signals operate. The **red** indicator  flashes and one of the indicators comes on, to show an alarm code:

-  - The appliance does not fill with water.

-  - The appliance does not drain the water.
-  - The appliance door is open or not closed correctly. Check the door!



WARNING!

Deactivate the appliance before you do the checks.

Problem	Possible solution
The programme does not start.	Make sure that the mains plug is connected to the mains socket.
	Make sure that the appliance door is closed.
	Make sure that there is not a damaged fuse in the fuse box.
	Make sure that the Start/Pause has been pressed.
	If the delay start is set, cancel the setting or wait for the end of countdown.
	Deactivate the Child Lock function if it is on.
The appliance does not fill with water.	Make sure that the water tap is open.
	Make sure that the pressure of the water supply is not too low. For this information, contact your local water authority.
	Make sure that the water tap is not clogged.
	Make sure that the filter of the inlet hose and the filter of the valve are not clogged. Refer to "Care and cleaning".
	Make sure that the inlet hose has no kinks or bends.
	Make sure that the connection of the water inlet hose is correct.
The appliance does not drain the water.	Make sure that the sink spigot is not clogged.
	Make sure that the drain hose has no kinks or bends.
	Make sure that the drain filter is not clogged. Clean the filter, if necessary. Refer to 'Care and cleaning'.
	Make sure that the connection of the drain hose is correct.
	Set the drain programme if you set a programme without drain phase.
	Set the drain programme if you set an option which ends with water in the tub.
The spin phase does not operate or the washing cycle lasts longer than usually.	Set the spin programme.
	Make sure that the drain filter is not clogged. Clean the filter, if necessary. Refer to 'Care and cleaning'.
	Adjust manually the items in the tub and start the spin phase again. This problem may be caused by balance problems.
There is water on the floor.	Make sure that the couplings of the water hoses are tight and there is not water leakages.

Problem	Possible solution
	Make sure that the drain hose have no damages.
	Make sure you use the correct detergent and the correct quantity of it.
You cannot open the appliance door.	Make sure that the washing programme is finished.
	Set the drain or the spin programme if there is water in the drum.
The appliance makes an unusual noise.	Make sure the levelling of the appliance is correct. Refer to 'Installation Instruction'.
	Make sure that the packaging and/or the transit bolts are removed. Refer to 'Installation Instruction'.
	Add more laundry in the drum. The load may be too small.
The appliance fills with water and drain immediately.	Make sure that the drain hose is in the correct position. The hose may be too low.
The washing results are not satisfactory.	Increase the detergent quantity or use a different detergent.
	Use special products to remove the stubborn stains before you wash the laundry.
	Make sure that you set the correct temperature.
	Decrease the laundry load.

After the check, activate the appliance.
The programme continues from the point of interruption.

If the problem occurs again, contact the Service.

13. TECHNICAL DATA

Dimensions	Width / Height / Depth	600 / 850 / 500 mm
	Total depth	542 mm
Electrical connection:	Voltage	230 V
	Overall power	2100 W
	Fuse	10 A
	Frequency	50 Hz
Level of protection against ingress of solid particles and moisture ensured by the protective cover, except where the low voltage equipment has no protection against moisture		IPX4
Water supply pressure	Minimum	0,5 bar (0,05 MPa)
	Maximum	8 bar (0,8 MPa)

Water supply ¹⁾	Cold water	
Maximum load	Cotton	6 kg
Spin speed	Maximum	1000 rpm (EWP 1062TDW)
		1400 rpm (EWP 1462TDW)

¹⁾ Connect the water inlet hose to a water tap with a 3/4" thread.

14. ENVIRONMENT CONCERNS

Recycle the materials with the symbol  . Put the packaging in applicable containers to recycle it. Help protect the environment and human health and to recycle waste of electrical

and electronic appliances. Do not dispose appliances marked with the symbol  with the household waste. Return the product to your local recycling facility or contact your municipal office.

www.electrolux.com/shop



192980260-A-322012

